

HDTV Supply, Inc.

Operating Instructions

Thanks for purchasing our product.
Please be sure to read this instruction
manual Carefully before using our product.



User Manual

Table of Contents

Contents

Introduction	4
HDMI Matrix	5
Product Overview	5
Features	5
Package Contents	7
Specifications	7
Panel Descriptions	8
Front Panel	8
Rear Panel	8
Side Panel	9
Installation	9
Operation	10
Maintenance	17
Product Service	17
Provided Service	17
Mail-In Service	17
Warranty	18
Warranty Limits and Exclusions	18

Introduction

This is a 4-by-2 HDMI true matrix. It allows any source (Blue-Ray player, HD DVD player, satellite receiver, game system, etc.) to be shown on the any of the two displays simultaneously, no matter the source is HDCP or not. Extra infrared receiver extension and IR emitter can control HDMI source and HDMI MATRIX.

This 4X2 HDMI Matrix Switch has the ability of equalization and amplification to ensure HDMI signal's transmission through long cable without quality loss.

This 4X2 HDMI Matrix Switch offers solutions for digital entertainment center, HDTV retail and show site, HDTV, STB, DVD and projector factory, noise, space and security concerns, data center control, information distribution, conference room presentation, school and corporate training environments.

HDMI Matrix

Product Overview (Model Number: MX0402-321)

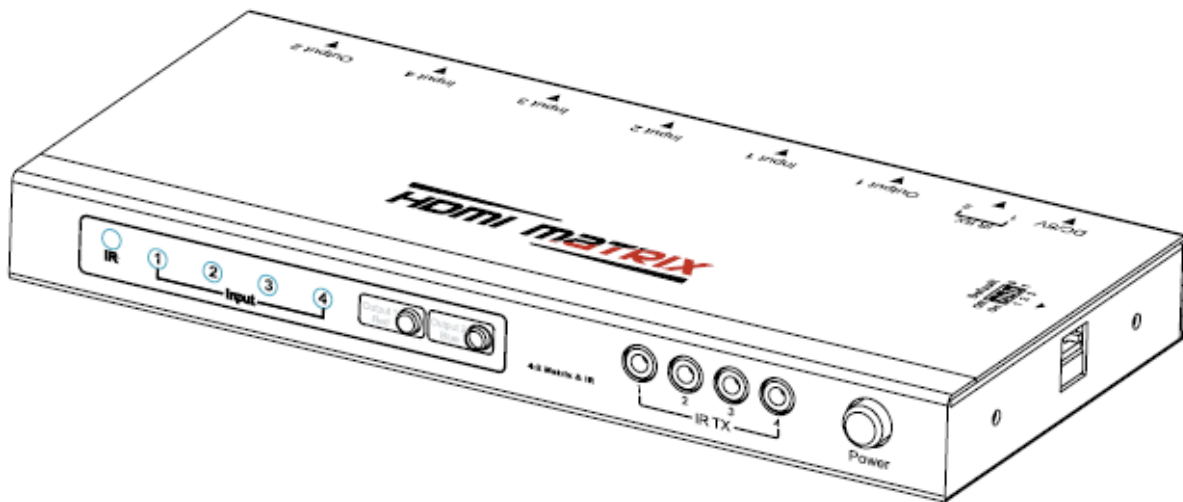

Features

- Easy to use: install in seconds, no need for setting.
- Allows up to four HDMI source devices to be independently switched to two HDMI monitors, HDTVs, or projectors.
- The two outputs could show the same or different source at the same time no matter the source is HDCP or not.
- Support high definition resolutions 1080P, 1080i, 720P and standard video format.
- Three switching modes: panel buttons, local IR, IR extension.
- With extra infrared receiver extension and IR emitter extension for IR call back function to control the HDMI source or HDMI MATRIX from remote rooms.
- HDCP compliant.
- HDMI 1.3 version.

Notice

HDTV Supply Inc. reserves the right to make changes in the hardware, packaging and any accompanying documentation without prior written notice.



Warning

To reduce the risk of fire, electric shock or product damage:



1. Do not expose this apparatus to rain, moisture, dripping or splashing and that no objects filled with liquids, such as vases, shall be placed on the apparatus.



6. Clean this apparatus only with dry cloth.



2. Do not install or place this unit in a bookcase, built-in cabinet or in another confined space. Ensure the unit is well ventilated.



7. Unplug this apparatus during lightning storms or when unused for long periods of time.



3. To prevent risk of electric shock or fire hazard due to overheating, do not obstruct the unit's ventilation openings with newspapers, tablecloths, curtains, and similar items.



8. Protect the power cord from being walked on or pinched particularly at plugs.



4. Do not install near any heat sources such as radiators, heat registers, stoves, or other apparatus (including amplifiers) that produce heat.



9. Only use attachments / accessories specified by the manufacturer.



5. Do not place sources of naked flames, such as lighted candles, on the unit.



10. Refer all servicing to qualified service personnel.

Package Contents

1. Main unit. P/N_MX0402-321.

2. 5VDC Power Supply. P/N_VDC0502.
3. 1x Remote.
4. 2x IR_RX (IR receiver) extension cable.
5. 4x IR_TX (IR emitter) extension cable.
6. 2x IR_RX cable extender jack pair.
7. Operating Instructions. P/N_INS MX0402-321.
8. 2x Mounting Ear.

 **NOTE:** PART NUMBER (Abbreviation as P/N).

Specifications

Operating Temperature Range	-5 to +35°C(-41 to +95 °F)
Operating Humidity Range	5 to 90 % RH (no condensation)
Input Video Signal	0.5-1.0 volts p-p
Input DDC Signal	5 volts p-p (TTL)
Signaling Rate	2.25Gbit/s
Video Format Supported	DTV/HDTV: 1080P/1080i/720P/576P/480P/576i/480i
Output Video	HDMI1.2 and HDMI 1.3
Audio Format Supported	DTS-HD、Dolby trueHD
Maximum Transmission Distance	<15m (If needed, HDMI extender is optional)
Power Consumption	10watts (Max.)
Dimensions	204mmL×95mmW×29mmH/8.0"L×3.7" W×1.1"H
Mass (Main Unit)	0.45kg

 **Note:** Specifications are subject to change without notice. Mass and dimensions are approximate.

Panel Descriptions

Front Panel

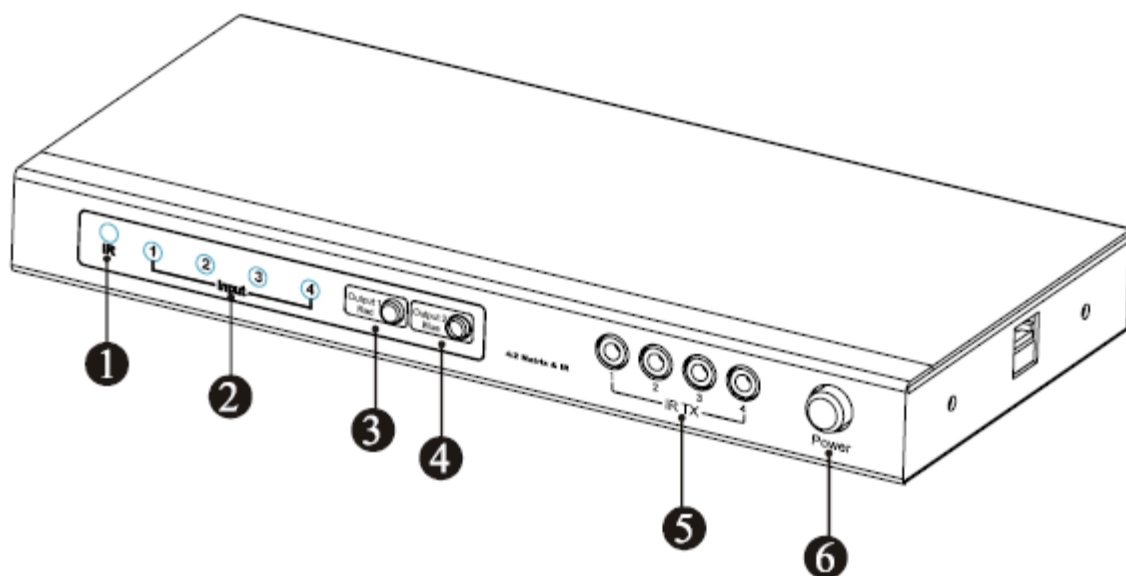

1. IR receiver.
2. Indicator of inputs (2 color LED, RED for Output1, BLUE for Output 2).
3. Input select button for Output 1.
4. Input select button for Output 2.
5. IR extension transmitter sockets.
6. Power switch.

Rear Panel

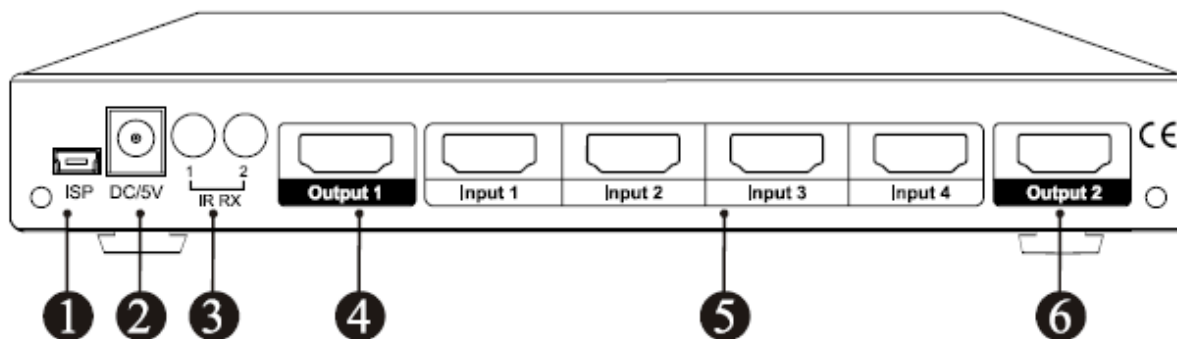

1. Mini USB for firmware update.
2. Power input.
3. IR extension receiver sockets.
4. HDMI output 1.
5. HDMI inputs.
6. HDMI output 2.

Side Panel

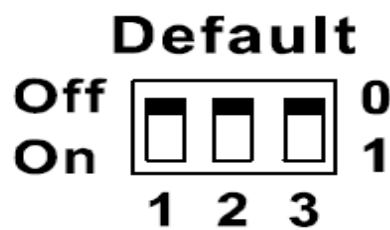
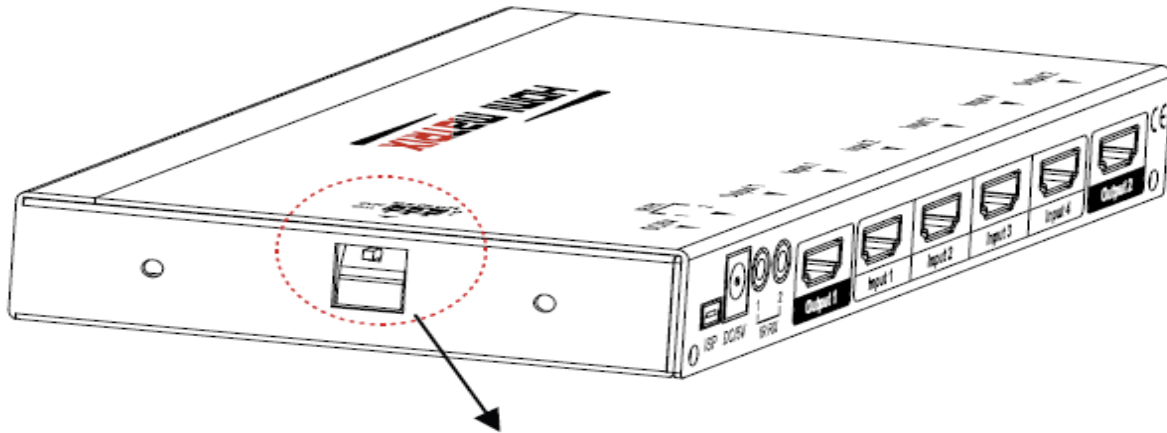

DIP switch for EDID setting.

Installation

1. Connect the HDMI input sources (such as HD-DVD, PS3, STB etc) into the matrix switch.
 2. Connect the HDMI outputs (such as HD-LCD, HD-DLP) into the matrix switch.
 3. Power on the input source you want to show. (Keep the unused input power off, otherwise it may interfere the normal display.)
 4. Connect the power supply into the matrix switch and turn on the display you want to watch.
 5. Use remote or push the button to choose input source. Extra infrared receiver extension and IR emitter are supplied for remote control.
 6. IR call back from remote rooms to control the HDMI Matrix function.
- **Attention:** Insert / Extract cables gently.

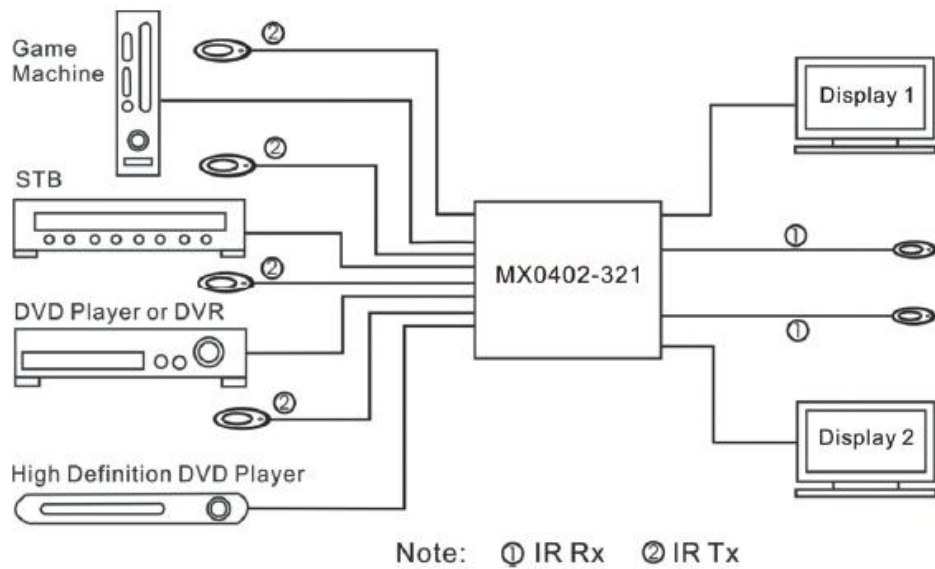

Operation

1. Front panel control.

The matrix switch front panel to select inputs to the various outputs.

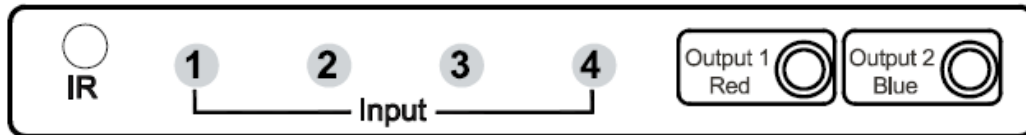

2. Local IR remote control.

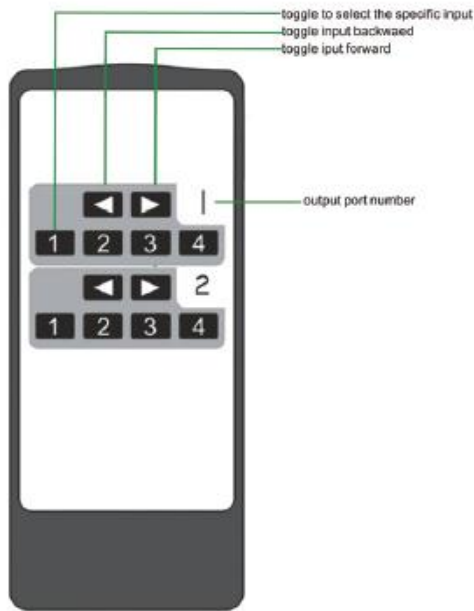

User can control the HDMI route of the matrix by using the IR remote.

There are two group key pads for two output ports. For each output port source selection, there are 4 number keys and two arrow keys. Press number keys to select specific input port. Left arrow button to backward the input port, and right arrow to forward input port.

3. IR extender control.

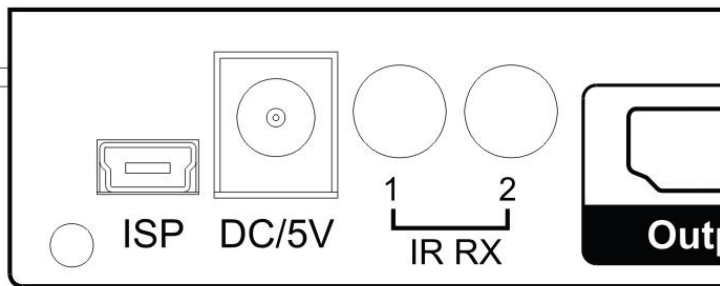

User can use the IR receiver cable to change the IR receiver position.

If controlling the matrix switch through the 1/8" (3.5 mm) input jack on the rear panel, connect the IR cable directly to the matrix rear IR receiver extension sockets.

4. IR call back system to control the source device.

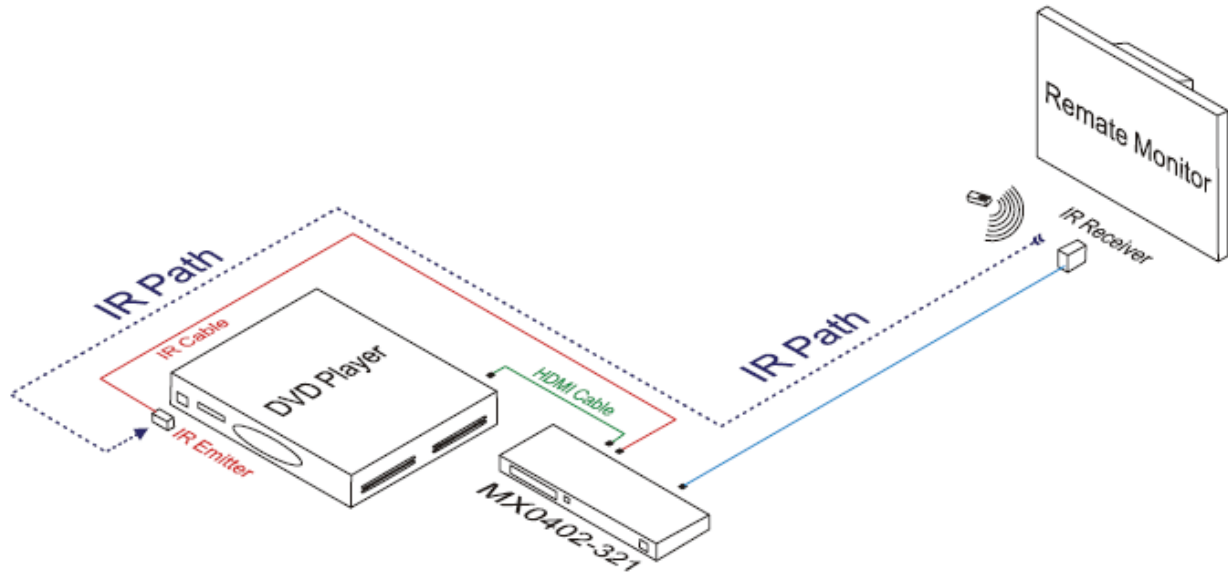

The matrix can not only extend the HDMI signal to HDMI receiver which is in remote rooms, but also can pass the IR signal through the IR call back system to the HDMI source.

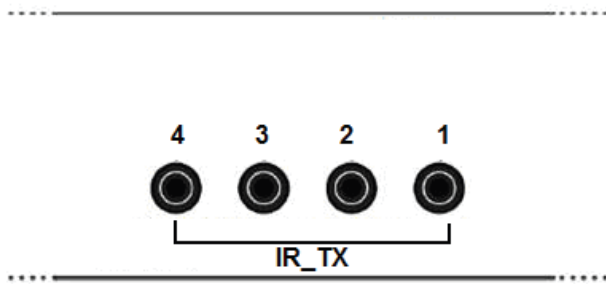

The IR emitter use low power infrared diode as emitter so that it will not interface other infrared signal. Please stick the IR emitter near to the IR window of the STB or DVD.

5. IR receiver cable extender jacks.

When the display device is not near to the matrix, the IR_RX cable will be to short. There are a pair of jacks to extend the IR_RX cable. Customer or installer can use the headphone cable or 4-line telephone cable to make the IR cable extender.



Use the male jack and female jack to extend the IR_RX cable like the picture below.

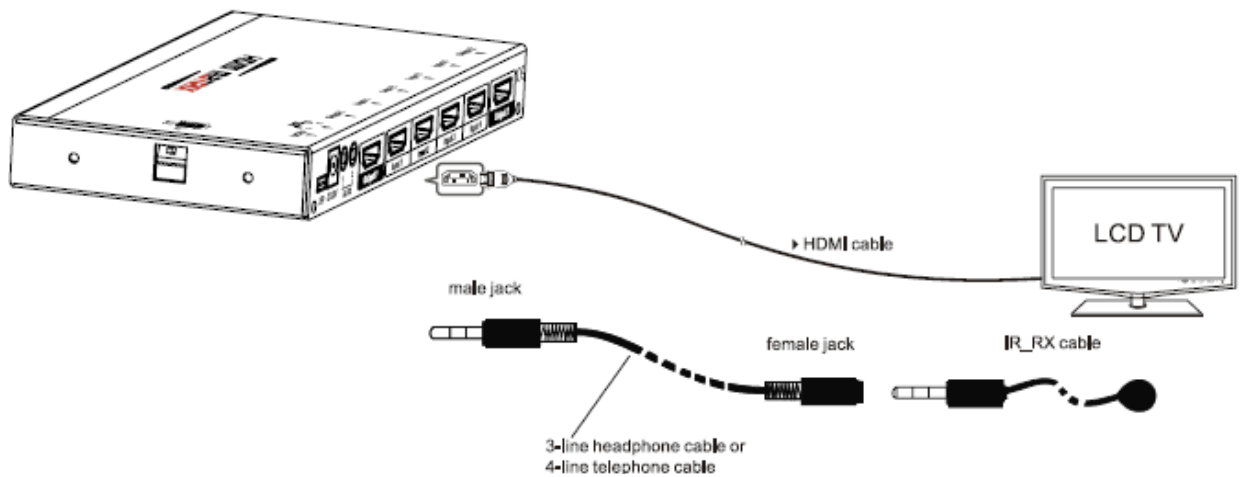

6. DIP switch for EDID setting. (Factory default setting: DIP in '000' mode, EDID are all 1080P stereo).

Position1	Position2	Position3	Function
0	0	0	Enable EDID manual mix, mix result is compatible with all HDMI sinks that choose the same source (Note1)
0	0	1	Enable EDID manual copy (Note2)
0	1	0	1080P stereo (Using Embedded EDID) (Note3)
0	1	1	1080i stereo (Using Embedded EDID) (Note4)

1	0	0	1080P 5.1 (Using Embedded EDID) (Note5)
1	0	1	1080P 7.1(Using Embedded EDID) (Note6)

- **Note1:** The matrix will mix the EDID data of all HDMI sinks that choose the same source. And forward this mixed EDID to the HDMI source device. The thought of EDID mixing is to enable all the connected sink device can have video and audio they can display or output. For example, One TV is 1080P, stereo, another is 1080i, 5.1 audio. The mixed EDID will be 1080i, stereo audio. (Press and hold output1 and output2 button simultaneously for 3 seconds to trigger this function)
- **Note2:** Copy operation is carried out under the appropriate trigger buttons. When output-2 select input-1, press and hold output2 for 3 seconds, the matrix will copy the output-2's edid to input-1.
- **Note3:** The matrix will use the embedded 1080P-stereo EDID when the DIP switch is in this mode. The EDID will be 1080P video and stereo audio.
- **Note4:** The matrix will use the embedded 1080i-stereo EDID when the DIP switch is in this mode. The EDID will be 1080i video and stereo audio. This setting can be used when the TV set is an old model that cannot support 1080P.
- **Note5:** The matrix will use the embedded 1080P-5.1 EDID when the DIP switch is in this mode. The EDID will be 1080P video and 5.1 audio.
- **Note6:** The matrix will use the embedded 1080P-7.1 EDID when the DIP switch is in this mode. The EDID will be 1080P video and 7.1 audio.
- **Note7:** When mix or copy function failed, the LEDs will lit for about 2 seconds. When mix or copy function no error occurred, The LEDs will flicker for three times.
- **Note8:** All settings will be effective only after repower.

Examples for EDID setting:

A. How to reset EDID to factory default setting?

Because the default EDID is 1080P stereo. So just set DIP to '010' and power on the matrix, all the EDID for input ports will be set to 1080P stereo. After reset the EDID data, the DIP switches can be set to '000' or '001' if user need future settings.

B. How to copy the EDID of AVR which is 7.1 audio to a input port?

- Set DIP to '001'.
- Connect the AVR to one of the output port (For example, output 1).
- Power on the matrix. Select the source of the AVR (for example input 2) to input port (For example, input 2) which is connected to a BD player.
- Press and hold the output1 key more than 3 seconds, the matrix will copy the EDID data from output 1 to input 2.

Below is the diagram for the some usage example.

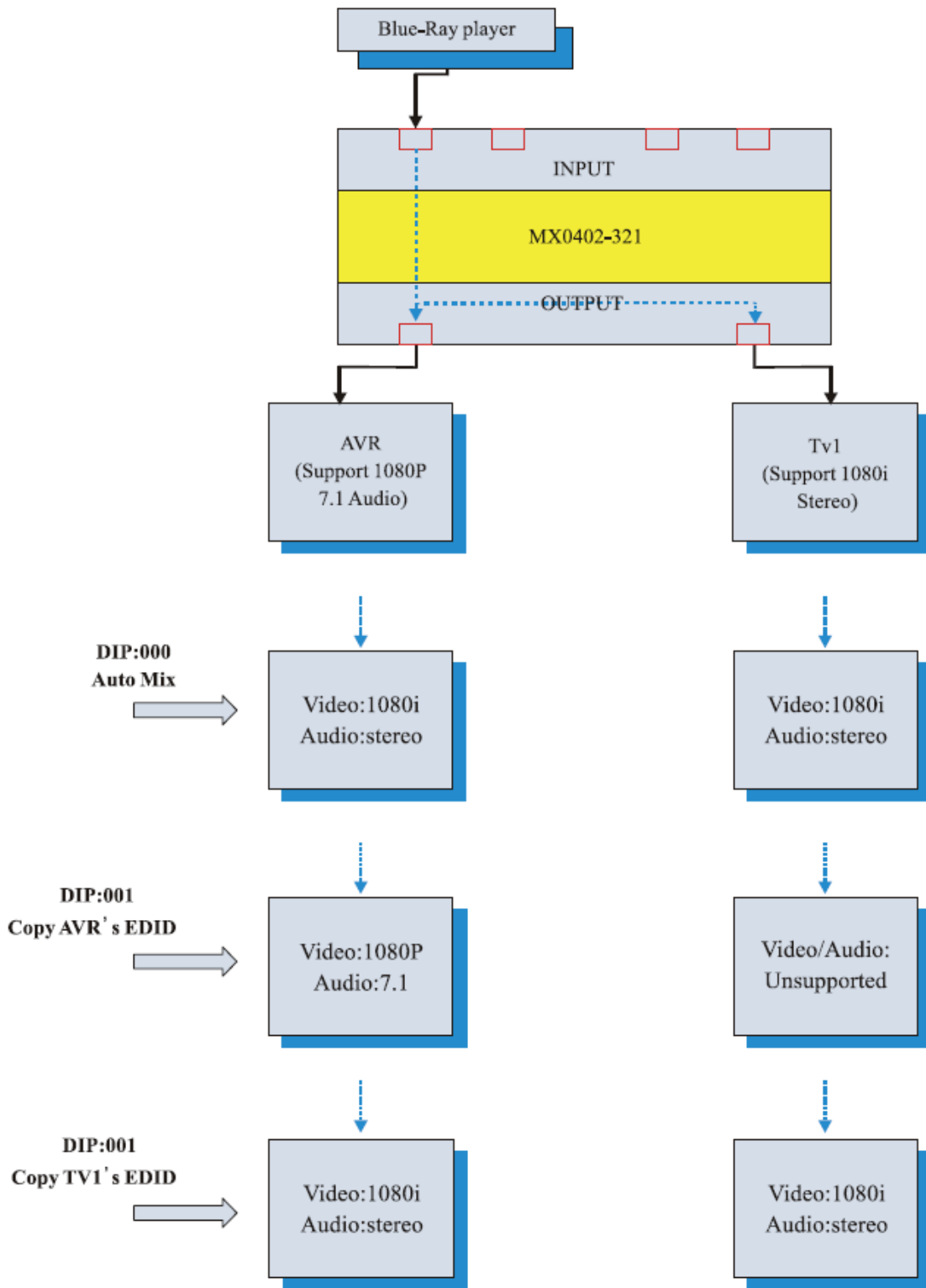

Maintenance

Clean this unit with a soft, dry cloth. Never use alcohol, paint thinner or benzene to clean this unit.

Product Service

● Provided Service

- 1) **Damage Requiring service:** The unit should be serviced by qualified service personnel if:
 - The DC power supply cord or AC adaptor has been damaged;
 - Objects or liquids have gotten into the unit;
 - The unit has been exposed to rain;
 - The unit does not operate normally or exhibits a marked change in performance;
 - The unit has been dropped or the cabinet damaged.
- 2) **Servicing Personnel:** Do not attempt to service the unit beyond that described in these operating instructions. Refer all other servicing to authorized servicing personnel.
- 3) **Replacement parts:** When parts need replacing ensure the service uses parts specified by the manufacturer or parts that have the same characteristics as the original parts. Unauthorized substitutes may result in fire, electric shock, or other hazards.
- 4) **Safety check:** After repairs or service, ask the service to perform safety checks to confirm that the unit is in proper working condition.

● Mail-In Service

When shipping the unit, carefully pack and send it prepaid, adequately insured and preferably in the original carton. Include a letter detailing the complaint and provide a daytime phone and/or email address where you can be reached.

If repair is needed during the limited warranty period the purchaser will be required to furnish a sales receipt/proof of purchase indicating date of purchase, amount paid and place of purchase. Customer will be charged for the repair of any unit received without such proof of purchase.

● Warranty

If your product does not work properly because of a defect in materials or workmanship, HDTV Supply (referred to as “the warrantor”) will, for the length of the period indicated as below, (**Parts (1) Year and Labor**) which starts with the date of original purchase (“Limited Warranty period”), at its option either (a) repair your product with new or refurbished parts, or (b) replace it with a new or a refurbished product. The decision to repair or replace will be made by the warrantor. During the “Labor” Limited Warranty period there will be no charge for labor.

During the “Parts” warranty period, there will be no charge for parts. You must mail-in your product during the warranty period. This Limited Warranty is extended only to the original purchaser and only covers product purchased as new. A purchase receipt or other proof of original purchase date is required for Limited Warranty service.

● Warranty Limits and Exclusions

- 1) **This Limited Warranty ONLY COVERS failures due to defects in materials or workmanship, and DOES NOT COVER normal wear and tear or cosmetic damage.** The Limited Warranty **ALSO DOES NOT COVER** damages which occurred in shipment, or failures which are caused by products not supplied by the warrantor, or failures which result from accidents, misuse, abuse, neglect, mishandling, misapplication, alteration, faulty installation, set-up

- adjustments, maladjustment of consumer controls, improper maintenance, power line surge, lightning damage, modification, or service by anyone other than a Factory Service Center or other Authorized Service, or damage that is attributable to acts of God.
- 2) **There are no express warranties except as listed under “limited warranty coverage” . The warrantor is not liable for incidental or consequential damages resulting from the use of this product, or arising out of any breach of this warranty. (As examples, this excludes damages for lost time, cost of having someone remove or re-install an installed unit if applicable, travel to and from the service location, loss of or damage to media or images, data or other recorded content. The items listed are not exclusive, but are for illustration only.)**
 - 3) **Parts and service, which are not covered by this limited warranty, are your responsibility.**